



**Totally Focused. Totally Independent.**

**EN**

User manual

# Anti-condensation Heater

Series ECO 40  
Series ECO 43  
Series ECO 46

Assembly instructions

Code: Heater\_EN  
Revision: 1  
Date: 14/07/17 15:04

Translation of original language



The world's largest  
independent producer of  
alternators 1 – 5,000kVA

<b>Contents</b> .....	<b>1</b>
<b>1 General Information: scope of the manual</b> .....	<b>1</b>
1.1 Intended Users .....	1
1.2 Professional profiles Involved .....	1
1.3 Manual use and storage .....	1
1.4 How to consult the manual .....	3
1.4.1 Description of the symbols/pictographs in the manual .....	3
1.5 Support .....	4
<b>2 Heater kit overview</b> .....	<b>5</b>
2.1 Main components .....	6
<b>3 Installation instructions</b> .....	<b>7</b>
3.1 Installation Setup .....	7
3.1.1 Assembly (Series ECO40-ECO43) .....	8
3.1.2 Assembly (Series ECO46) .....	10
3.2 Assembly drawings .....	12
<b>4 Dismantlement and disposal</b> .....	<b>15</b>
4.1 How to dispose of the packing materials .....	15

# 1 General Information: scope of the manual

In this manual you will find the procedure for a correct fitting of the anti-condensation heater kit on alternators Series ECO40-ECO43-ECO46 manufactured by Mecc Alte S.p.A. company.



This document and/or its parts may not be reproduced or disclosed to third parties without the prior consent of MECC ALTE S.p.A.



MECC ALTE S.p.A. is not responsible or liable for any damages suffered by people or things as a result of improper use not indicated in this manual and by failure to comply with the specifications of the technical characteristics table pertaining to every model.

## 1.1 Intended Users

This manual is intended for the authorized personnel adequately trained to operate this kind of product.

### Warning



The operators must not carry out operations reserved to maintenance technicians or to specialized technicians. The Manufacturer disclaims all responsibility for damages suffered as a result of failure to comply with this warning.

## 1.2 Professional profiles Involved

Below we describe the professional profiles who may operate the alternator based on the kind of activity to be carried out.

### Electrical Maintenance Operator



A qualified technician in charge with all the electrical works of connection, adjustment, maintenance and repair. Authorized to carry out operations with the power on.

## 1.3 Manual use and storage

### Warning



Read this manual carefully before starting up the alternator or carrying out any operation on it. If you do not read it you might not be able to recognize potential hazardous situations that may lead to death or serious injuries inflicted to yourself or to others.

This manual is intended to provide all the information required for a correct use of the alternator and its most autonomous and safest possible management.

It is mandatory for all the users and the maintenance technicians to carefully read the instructions contained in this manual and in all possible annexes, before carrying out any operation on the product.

In case of doubts on the correct interpretation of the information reported in the documentation, please contact the manufacturer for clarifications.

**Caution**



Keep this manual and all its annexes in good condition, legible and complete in all its parts. Keep the documentation close to your alternator, in an accessible place known to all the operators and maintenance technicians and, more generally, to everyone who for various reasons should operate the alternator.

**Warning**



Keep the manual in its original condition. It is forbidden to rewrite, change or remove pages from the manual and their contents. The manufacturer disclaims all responsibility for any potential damages to people, animals or things as a result of failure to comply with the instructions and with the operational modalities described in this manual.

**Caution**



In case the manual is lost or damaged ask for a copy from the Manufacturer indicating its identification data: document name, code, revision number and issue date.

## 1.4 How to consult the manual

- The manual is divided in chapters, paragraphs and subparagraphs listed in the table of contents: an easy way to find any topic of interest.
- The symbols used provide direct knowledge on the kind of information expressed by each symbol. For instance the symbol:



This symbol indicates a NOTE.

### 1.4.1 Description of the symbols/pictographs in the manual

Below you will find the various symbols used in the manual to highlight information of particular importance or the intended recipients of the specific pieces of information.

#### Danger



The risks described in this manner indicate a HIGH LEVEL of hazard that, unless avoided, could cause severe injuries or death.

#### Warning



The risks described in this manner indicate an INTERMEDIATE LEVEL of hazard that, unless avoided, could cause severe injuries or death.

#### Caution



The risks described in this manner indicate a LOW LEVEL of hazard that, unless avoided, could cause minor or moderate injuries.



This symbol indicates a NOTE; a fundamentally important piece of information or in-depth explanation.



This symbol indicates a CROSS REFERENCE; the presence of a module, of a drawing or of an annexed document that should be consulted and, if required, filled in.

## 1.5 Support

For any inquiry on the use, the maintenance or a request of replacement parts, the buyer must contact the Manufacturer directly (or the help desk if present), specifying the alternator identification data indicated on the identification tag.

The Customer may resort to the technical and commercial support provided by the area representatives or by foreign branches, which are in direct contact with MECC ALTE S.p.A. and have their addresses and contact data indicated on the back cover.

In case of fault or an insurmountable inconvenience, the Customer may contact directly the headquarters using the following data:

PHONE NUMBER (Landline):	+ 39 0444 396111
FAX NUMBER:	+ 39 0444 396166
E-MAIL:	aftersales@meccalte.it
WEBSITE:	www.meccalte.com
MAILING ADDRESS:	MECC ALTE S.p.A Via Roma 36051 Creazzo, Vicenza Italy

## 2 Heater kit overview

The anti-condensation heater kit contains all the necessary for a correct installation.



See listed components at paragraph 2.1



At the receiving of the kit verify on the box label that technical characteristics correspond to what ordered.



#5\_HEA\_001-r00

The heater is a device that, opportunely feeded, allows to remove the condensation inside the alternator.

### Caution



We recommend to use this device every time the alternator did not work for long periods or every time presence of condensation /humidity on the winding is supposed.

### Caution



Heater has to work for at least 24 hours, before the alternator starting which has to be done only after the measure of the insulation resistance of the windings.

## 2.1 Main components

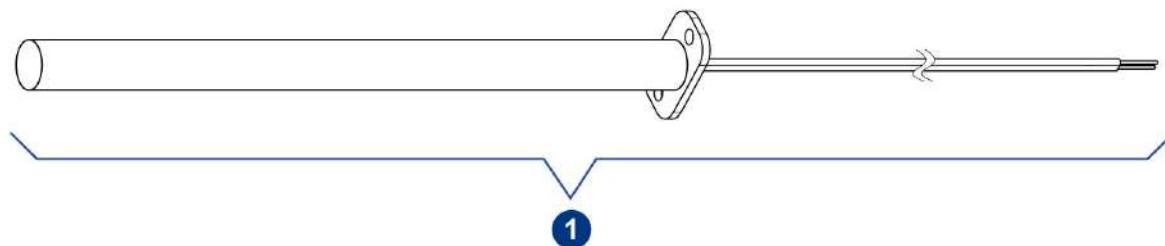

06\_HEA\_001-00

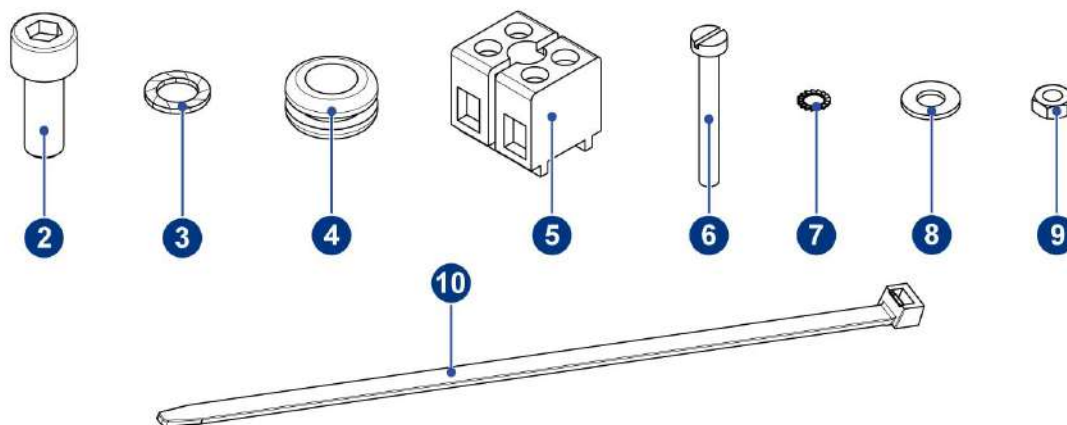

06\_HEA\_002-00

- |  |  |
|--|--|
| 1. Dew heater                            | 6. Slotted cheese head screw M3x25 UNI EN ISO 1207 |
| 2. Socked head screw M6x16 UNI 5931 (x2) | 7. Toothed washer D.3 UNI 8842 (x2)                |
| 3. Safety washer SCHNORR D.6 (x2)        | 8. Plain washer D.4 UNI 6592                       |
| 4. Black rubber grommet D.10             | 9. Hexagonal-head nut M3 UNI 5587                  |
| 5. MK-3/12 KRG Terminal board - 2 Pin    | 10. Nylon cable tie 3,5x140 white                  |



## 3 Installation instructions

### Warning



The final installer is in charge with assembling all the safeguards (disconnect switches, safeguards against direct and indirect contact, safeguards against overcurrent and overvoltage, emergency stop and so on) required to make the machine and the user system comply with the European and International Safety Regulations.



The installation operations of the heater must be carried out by qualified personnel.



### Danger

The alternator must be stationary during the heater assembly.

### 3.1 Installation Setup



The alternator must be grounded before installation. Please ensure that the grounding system is effective and it complies with the directives of the country where the alternator will be installed.

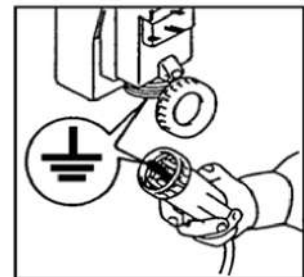

dis\_ECO\_034-r00

### 3.1.1 Assembly (Series ECO40-ECO43)

#### Detailed assembling procedure

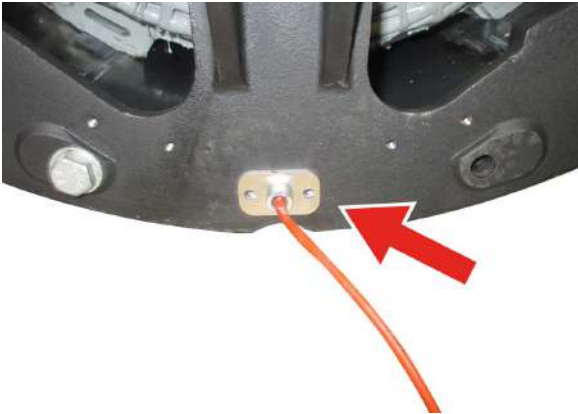

Remove the protective rubber and insert the heater into the hole.

Fix the heater with:

- 2 Socked head screw M6x16 UNI 5931
- 2 Safety washer SCHNORR D.6

Apply a 9Nm  $\pm$ 7% tightening torque.



See also Drawing n.1 par. 3.2



Insert the black rubber grommet D.10 to let the heater cable pass through as shown in figure.



The cables must never present tensile stresses in the path from the heater to the V-closure but always have an adequate radius of curvature without ever touching the screw and staying correctly distanced from it.

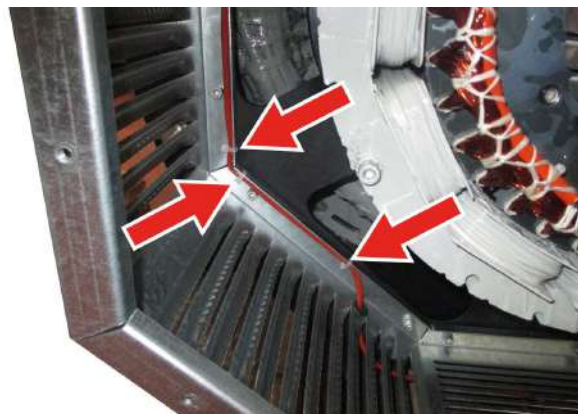

Identify the holes on the V closure inner fold, in order to fasten heater cable using the 3,5x140 nylon cable tie as shown in the figure.



The cables must never present tensile stresses in the path of the V closure inner fold.

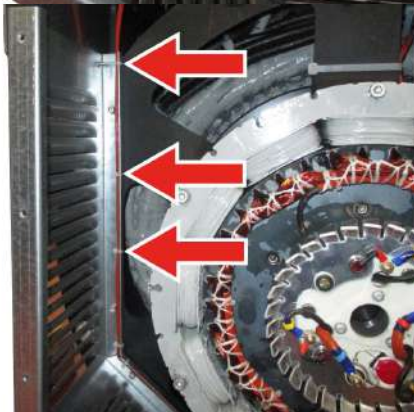

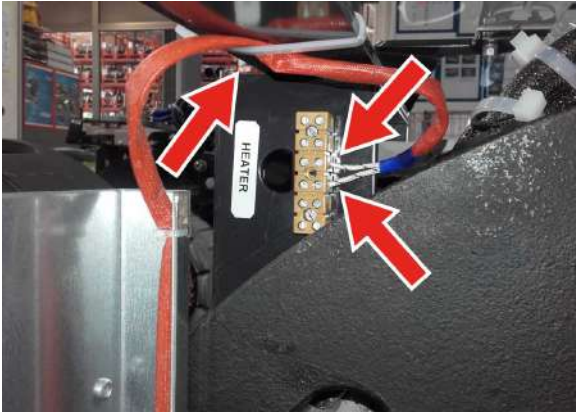

**Only Series ECO40**

Pass the cables as shown in figure.

Fix the the MK-3/12 KRG - 2 Pin terminal board with:

- Slotted cheese head screw M3x25 UNI EN ISO 1207
- Toothed washer D.3 UNI 8842 (x2)

Insert the two wires of the heater into the previously fixed terminal board.

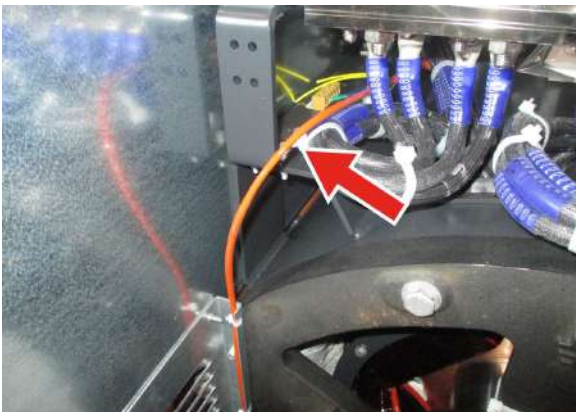

**Only Series ECO43**

Pass the cables as shown in figure.

Fix the the MK-3/12 KRG - 2 Pin terminal board with:

- Slotted cheese head screw M3x25 UNI EN ISO 1207
- Toothed washer D.3 UNI 8842 (x2)

Insert the two wires of the heater into the previously fixed terminal board.

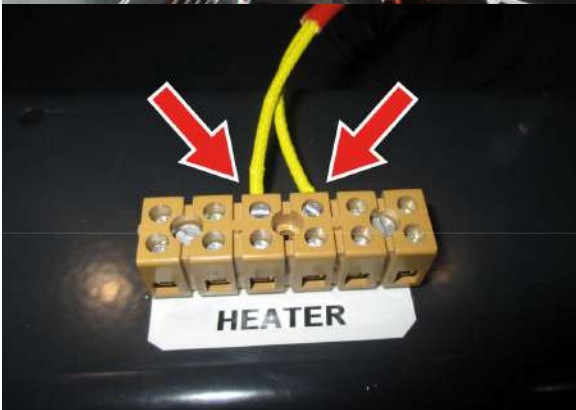

### 3.1.2 Assembly (Series ECO46)

#### Detailed assembling procedure

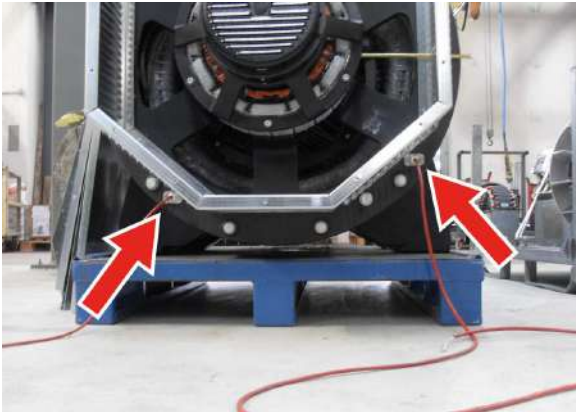

Remove the protective rubber and insert the heater into the hole.

Fix the heater with:

- 2 Socked head screw M6x16 UNI 5931
- 2 Safety washer SCHNORR D.6

Apply a 9Nm  $\pm$ 7% tightening torque.



See also Drawing n.1 par. 3.2



Insert the black rubber grommet D.10 to let the heater cable pass through as shown in figure.



The cables must never present tensile stress in the path from the heater to the V-closure but always have an adequate radius of curvature without ever touching the screw and staying correctly distanced from it.

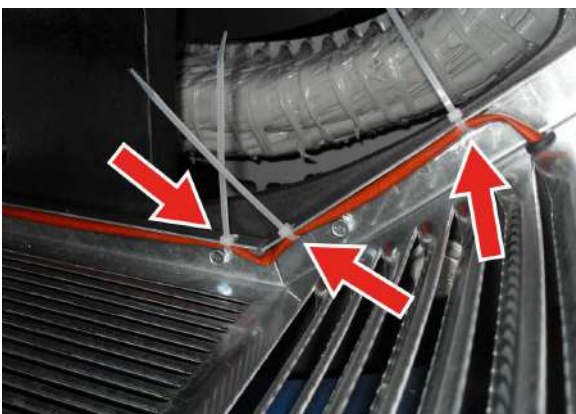

Identify the holes on the V closure inner fold, in order to fasten heater cable using the 3,5x140 nylon cable tie as shown in the figure.



The cables must never present tensile stresses in the path of the V closure inner fold.

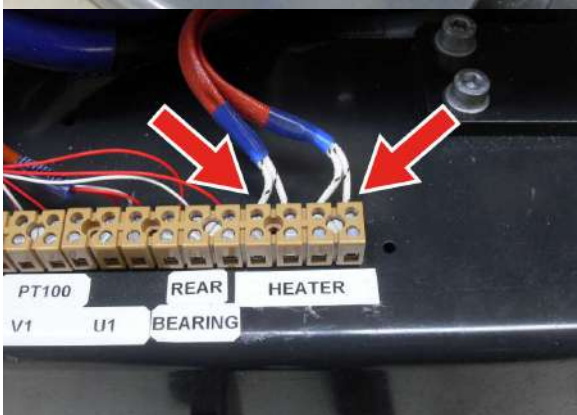
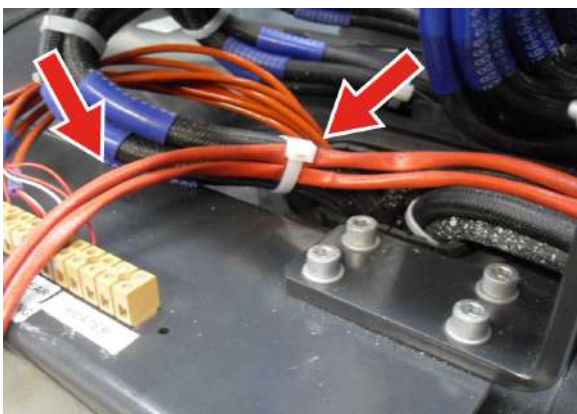
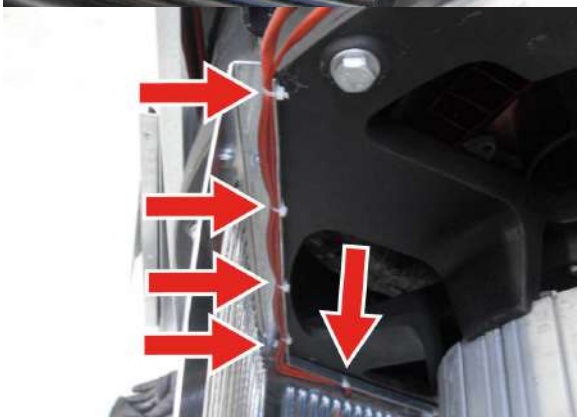

Pass the cables as shown in figure and fix the cables to the cable assembly.

Fix the the MK-3/12 KRG - 2 Pin terminal board with:

- Slotted cheese head screw M3x25 UNI EN ISO 1207
- Toothed washer D.3 UNI 8842 (x2)

Insert the two wires of the heater into the previously fixed terminal board.

### 3.2 Assembly drawings

B0125: ECO40 - ECO43 - ECO46 Heater assembly drawing

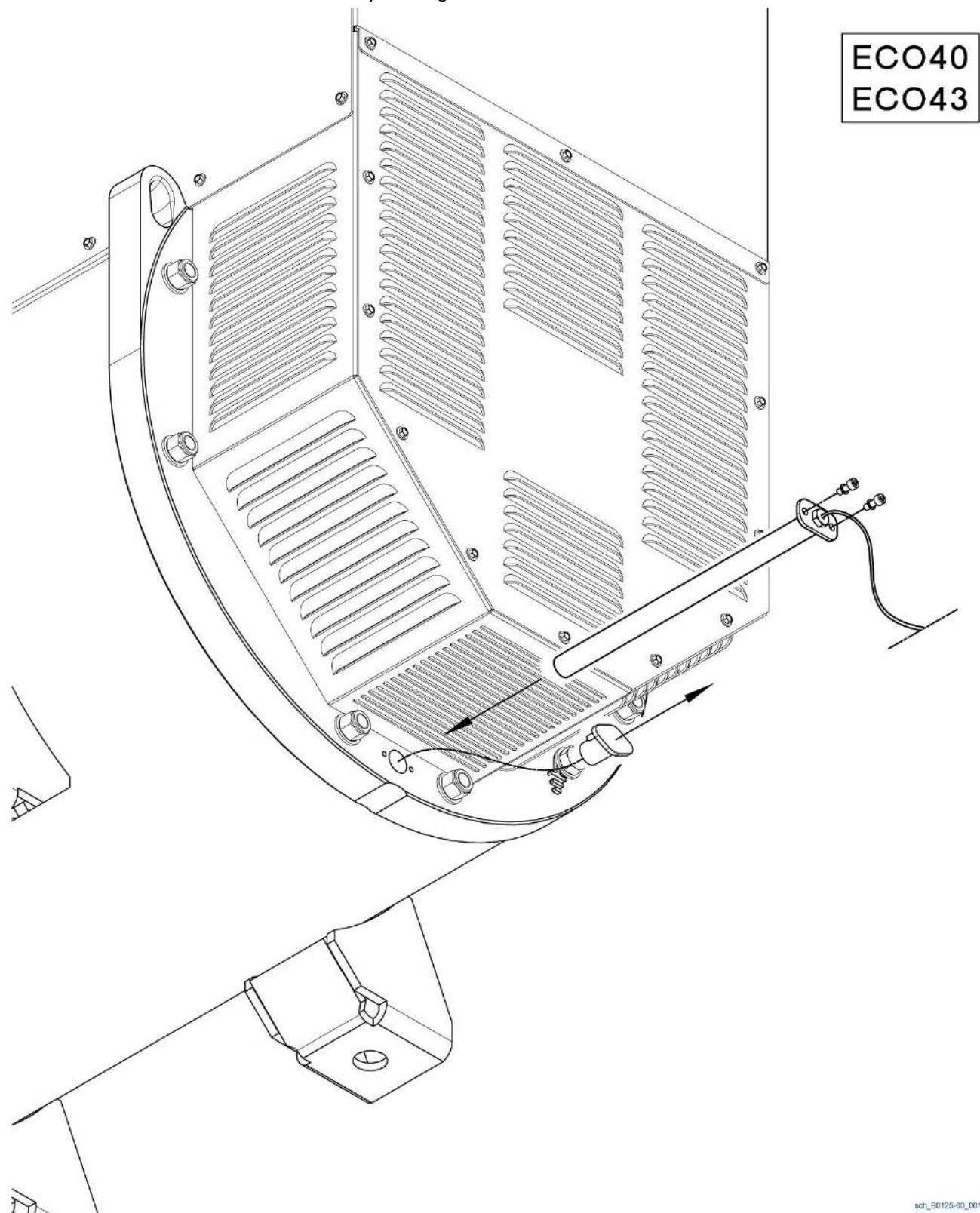

Drawing n.1

sch\_B0125-00\_001+00

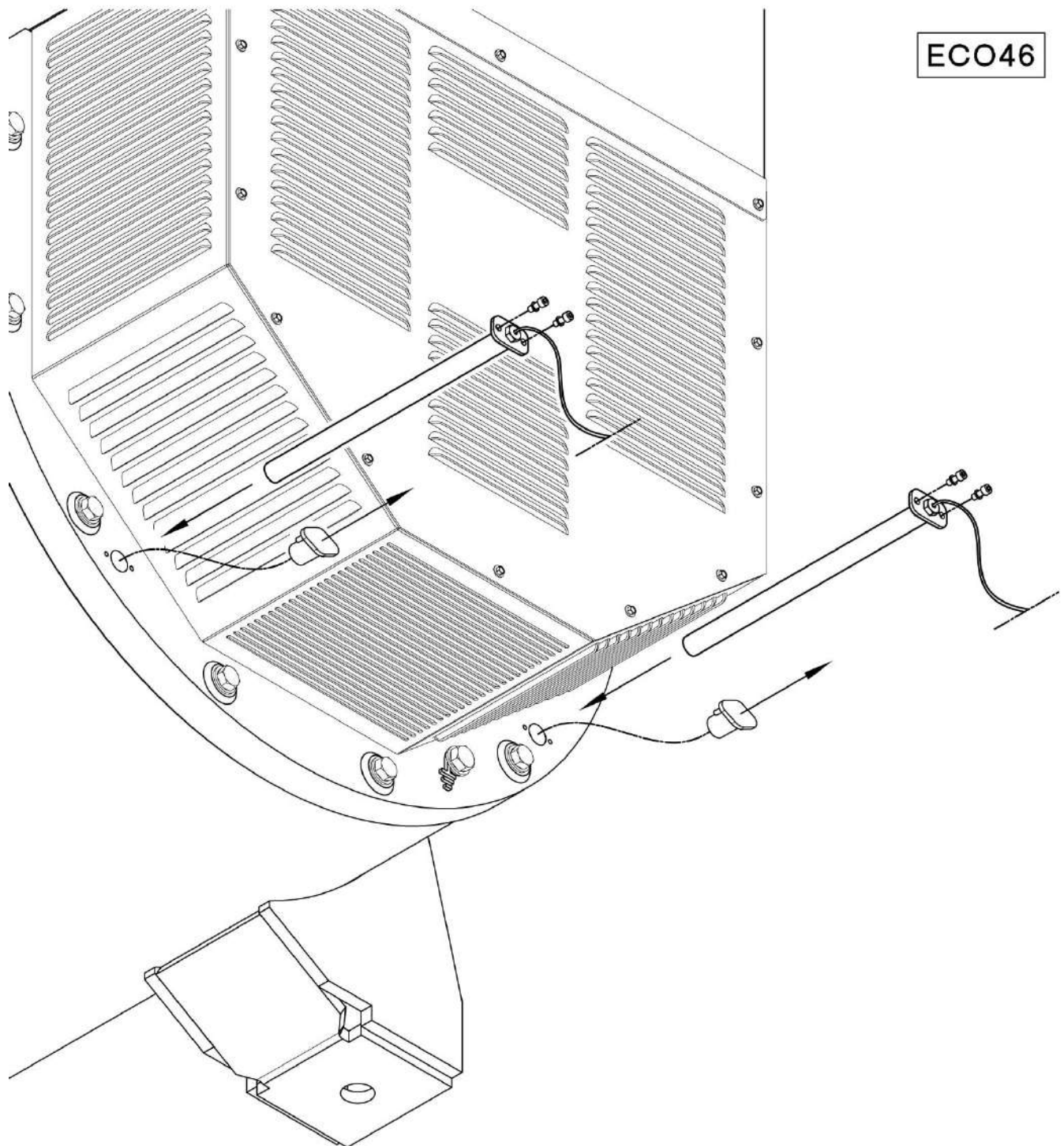

*Drawing n.2*





## 4 Dismantlement and disposal

When recycling , keep in mind the nature of its various components (for instance: metals, plastic parts, rubber, oil and so on). You will have to designate specialized companies for this purpose and , however, observe the waste management applicable laws.



Most of the materials can be recycled by specialized waste management companies. The instructions contained in this chapter are recommendations to follow for environmentally sound disposal; the user has the responsibility of observing local regulations.

### 4.1 How to dispose of the packing materials



Dispose of packaging differentially.

---

**Mecc Alte SpA (HQ)**

Via Roma  
20 – 36051 Creazzo  
Vicenza – ITALY  
T: +39 0444 396111  
F: +39 0444 396166  
E: info@meccalte.it  
aftersales@meccalte.it

---

**Mecc Alte Portable**

Via A. Volta  
1 – 37038 Soave  
Verona – ITALY  
T: +39 045 6173411  
F: +39 045 6101880  
E: info@meccalte.it  
aftersales@meccalte.it

---

**Mecc Alte Power Products srl**

Via Melaro  
2 – 36075 Montecchio  
Maggiore (VI) – ITALY  
T: +39 0444 1831295  
F: +39 0444 1831306  
E: info@meccalte.it  
aftersales@meccalte.it

---

**Zanardi Alternators**

Via Dei Laghi  
48/B – 36077 Altavilla  
Vicenza – ITALY  
T: +39 0444 370799  
F: +39 0444 370330  
E: info@zanardialternatori.it

---

**United Kingdom**

Mecc Alte U.K. LTD  
6 Lands' End Way  
Oakham  
Rutland LE15 6RF  
T: +44 (0) 1572 771160  
F: +44 (0) 1572 771161  
E: info@meccalte.co.uk  
aftersales@meccalte.co.uk

---

**Spain**

Mecc Alte España S.A.  
C/ Río Taibilla, 2  
Polig. Ind. Los Valeros  
03178 Benijofar (Alicante)  
T: +34 (0) 96 6702152  
F: +34 (0) 96 6700103  
E: info@meccalte.es  
aftersales@meccalte.es

---

**China**

Mecc Alte Alternator Haimen LTD  
755 Nanhai East Rd  
Jiangsu HEDZ 226100 PRC  
T: +86 (0) 513 82325758  
F: +86 (0) 513 82325768  
E: info@meccalte.cn  
aftersales@meccalte.cn

---

**India**

Mecc Alte India PVT LTD  
Plot NO: 1, Sanaswadi  
Talegaon  
Dhamdhare Road Taluka:  
Shirur, District:  
Pune - 412208  
Maharashtra, India  
T: +91 2137 619600  
F: +91 2137 619699  
E: info@meccalte.in  
aftersales@meccalte.in

---

**U.S.A. and Canada**

Mecc Alte Inc.  
1229 Adams Drive  
McHenry, IL, 60051  
T: +1 815 344 0530  
F: +1 815 344 0535  
E: info@meccalte.us  
aftersales@meccalte.us

---

**Germany**

Mecc Alte Generatoren GmbH  
Ensener Weg 21  
D-51149 Köln  
T: +49 (0) 2203 503810  
F: +49 (0) 2203 503796  
E: info@meccalte.de  
aftersales@meccalte.de

---

**Australia**

Mecc Alte Alternators PTY LTD  
10 Duncan Road, PO Box 1046  
Dry Creek, 5094, South  
Australia  
T: +61 (0) 8 8349 8422  
F: +61 (0) 8 8349 8455  
E: info@meccalte.com.au  
aftersales@meccalte.com.au

---

**France**

Mecc Alte International S.A.  
Z.E. La Gagnerie  
16330 ST. Amant de Boixe  
T: +33 (0) 545 397562  
F: +33 (0) 545 398820  
E: info@meccalte.fr  
aftersales@meccalte.fr

---

**Far East**

Mecc Alte (F.E.) PTE LTD  
19 Kian Teck Drive  
Singapore 628836  
T: +65 62 657122  
F: +65 62 653991  
E: info@meccalte.com.sg  
aftersales@meccalte.com.sg



[www.meccalte.com](http://www.meccalte.com)